

# GL2 COMPACT



## Compact, powerful and efficient LED lighting solution

GL2 COMPACT offers a unique combination of features in a slender housing for lighting the entrance, threshold and interior zones of a tunnel.

Available in five sizes and with various lumen packages, GL2 COMPACT offers high resistance to water, dust ingress and impacts.

The photometry of GL2 COMPACT can be either symmetrical or asymmetrical to adapt to the tunnel layout. This lighting solution offers a uniform lighting and superior visibility in critical areas such as the entrance and exit zones of a tunnel.

GL2 COMPACT offers several mounting possibilities. For example, it can be fixed directly onto a cable rack. The photometry can be adjusted on-site thanks to a tiltable bracket.

GL2 COMPACT guarantees long-lasting performance with minimum maintenance.

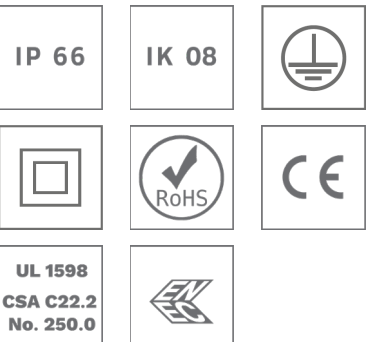

## Concept

The GL2 COMPACT range combines the energy efficiency of LED technology with photometric versatility for a minimum total cost of ownership. The design of the LensoFlex®2 photometric engine offers maximum versatility for lighting underpasses, town and motorway tunnels.

Available with symmetrical or asymmetrical light distributions, GL2 COMPACT adapts perfectly to the requirements of the space to be lit.

It is composed of an extruded aluminium body and a tempered glass protector.

GL2 COMPACT is available in five sizes and with a variable number of LEDs (from 16 to 96) to fit all requirements.

For further savings, GL2 COMPACT can be controlled via a DALI or 1-10V protocol or via a dedicated luminaire controller (Lumgate) connected to an industrial bus (option).

The GL2 COMPACT range has been developed to enable constant dimming with an optimised power factor. Designed with two electronic circuits, each GL2 COMPACT 4 or GL2 COMPACT 5 luminaire can either be dimmed completely, partially or even have 50% of its LEDs switched off. This possibility not only maximises energy savings. It also extends the lifetime of the complete installation and reduces the need for disruptive maintenance.

GL2 COMPACT is proposed with various direct and swivelling mounting options. This range is part of Schröder's complete tunnel solution that includes robust luminaires, smart cabling with quick-on QPD connectors and advanced control systems to improve safety for drivers and to provide significant operational benefits for tunnel managers.



GL2 COMPACT is equipped with a flat extra-clear tempered glass protector.

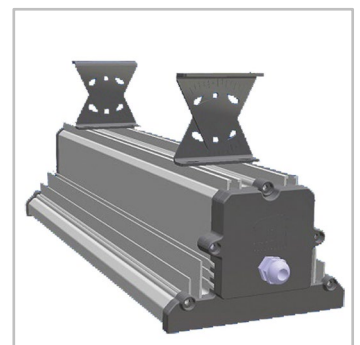

Suspended mounting is completed with a swivelling bracket that is adjustable on-site (+/- 60°).

## TYPES OF APPLICATION

- TUNNELS & UNDERPASSES
- INDUSTRIAL HALLS & WAREHOUSES

## KEY ADVANTAGES

- Maximised savings in energy and maintenance costs
- High tightness level and excellent heat dissipation for long lasting performance
- High level of protection against corrosion, impacts and vibrations
- LensoFlex®2 technology offering high performance photometry, comfort and safety
- Two electrical circuits for enhanced dimming possibilities, optimised power factor and longer lifespan
- Can be equipped with an integrated luminaire controller (Lumgate) for automated commissioning and bi-directional controls (option)
- On-site adjustment for optimal photometry

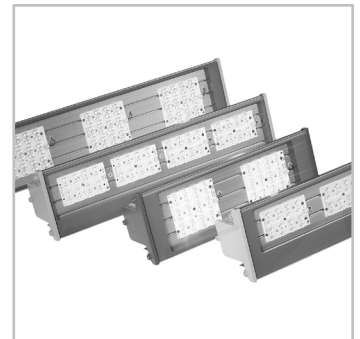

GL2 COMPACT is available in 5 sizes for flexibility.



As an option, the GL2 COMPACT luminaires come with tool less QPD connectors for an easy and quick installation.



## LensoFlex®2

LensoFlex®2 is based upon the addition principle of photometric distribution. Each LED is associated with a specific PMMA lens that generates the complete photometric distribution of the luminaire. The number of LEDs in combination with the driving current determines the intensity level of the light distribution.



## Back Light control

As an option, the LensoFlex®2 and LensoFlex®4 modules can be equipped with a Back Light control system.

This additional feature minimises light spill from the back of the luminaire to avoid intrusive light towards buildings.

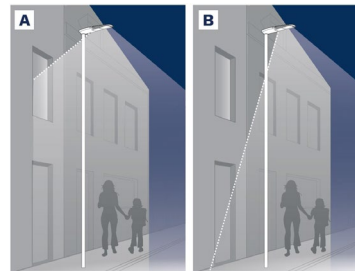

A. Without Back Light control | B. With Back Light control

## Advanced Tunnel Solution (ATS)

The ATS (Advanced Tunnel Solution) is a control system that manages luminaire controllers (Lumgates) to deploy pre-defined lighting scenarios or to take charge of the lighting installation at any moment.

The ATS controller can operate as a standalone unit or can be linked to the main tunnel control system to interact with features not directly related to lighting (traffic management, ventilation, fire detection etc.).



## Luminance meter (L20)

The luminance meter measures the luminance provided by natural light in the access zone from the safe stopping distance. It sends the data to the ATS control system that adjusts the lighting levels to avoid any visual adaptation problems.



## Lumgate

The Lumgate is an RS485 closed-loop device connected to the luminaire drivers to control the light intensity and provide command/reporting features.

One Lumgate can control several luminaires.



## Tunnel Control System (TCS)

The Tunnel Control System (TCS) is a gateway ensuring the connection/control of the multiple ATS controllers as well as the communication with the central management system of the tunnel infrastructure (SCADA) if applicable.





Jointly developed by Schröder and Phoenix Contact, the Advanced Tunnel Solution (ATS) has been designed to control every lighting point or clusters of luminaires to perfectly adapt the lighting level according to conditions in the tunnel, to monitor the power consumption and to report the burning hours or any failure to facilitate maintenance. The system includes a self-commissioning feature and enables scenarios to be adapted remotely at any moment.

## PRECISE AND CONTINUOUS DIMMING

ATS provides 25 different dimming levels to precisely adapt the lighting to the real needs. Without any over-lighting, the energy consumption is limited to what is absolutely necessary to ensure safe and comfortable driving conditions.

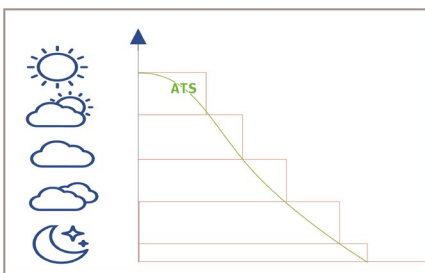

## FLEXIBILITY

Flexible redundancy offers security on multi-level applications, not only for the lighting.

## PLUG AND PLAY COMMISSIONING

The tunnel lighting study can be directly imported into the ATS control system.

This unique feature, in combination with the auto-addressing of the Lumgates, leads to an extremely short commissioning time once the fixtures have been installed.

Each luminaire or cluster of luminaires is attributed the precise dimming profile linked to its position and characteristics.

## INTERACTION WITH THIRD PARTY SYSTEMS

Every command or signal sent to or coming from a tunnel component (emergency exit, smoke extraction system, traffic management system...) can be used to trigger a responsive lighting scenario. All of the tunnel equipment can be controlled through the same bus command.

## MAXIMISED SAFETY

The system enables the easy set-up of emergency and disaster management scenarios.

## ADAPTIVE LIGHTING ACCORDING TO SPEED

The ATS can be linked to a traffic monitoring system to obtain data regarding speed or density to adapt the lighting level according to safety standards. This option further reduces energy consumption and increases the lifetime of the installation while ensuring the best driving conditions for motorists.

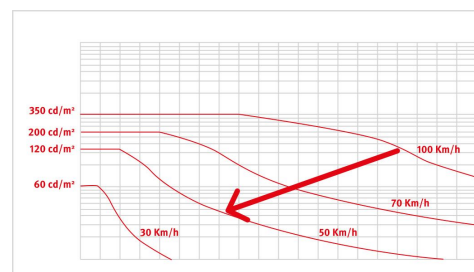

## ADAPTIVE LIGHTING ACCORDING TO POLLUTION

Based on cleaning cycles, the ATS can take into account the depreciation of the flux due to dirt accumulation to continuously provide the requested lighting level in the tunnel. No more, no less. This feature offers additional energy savings while providing safety and comfort for users.

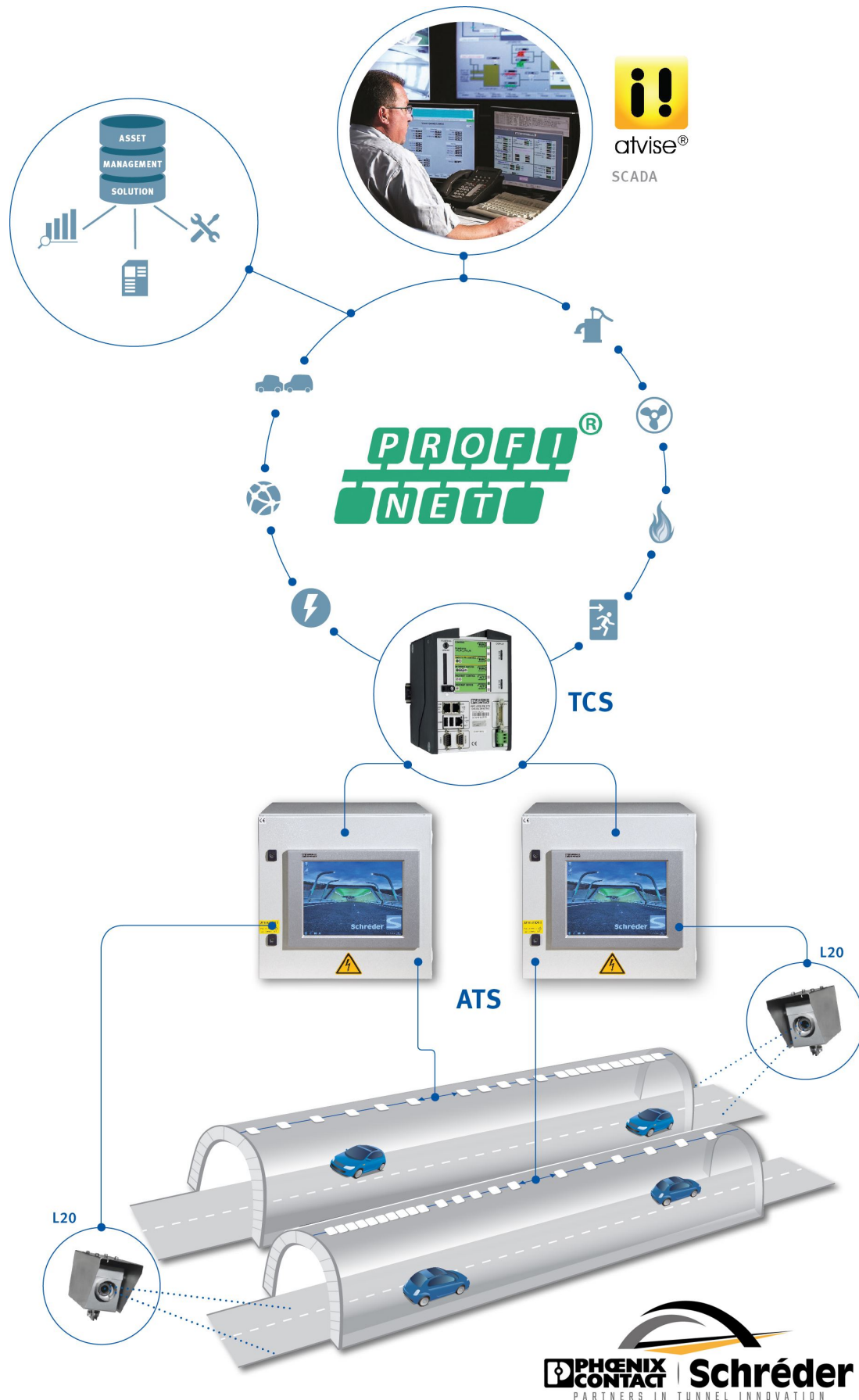

## GENERAL INFORMATION

Recommended installation height	3m to 8m   10' to 26'
Driver included	Yes
CE mark	Yes
ENEC certified	Yes
UL certified	Yes
ROHS compliant	Yes
Testing standard	LM 79-08 (all measurements in ISO17025 accredited laboratory) EN 60598-2-13:2006+A1:2012+A2:2016

## HOUSING AND FINISH

Housing	Aluminium
Optic	PMMA
Protector	Tempered glass
Housing finish	Standard polyester powder coating (C2-C3 according to the ISO 9223-2012 standard) Optional "seaside" polyester powder coating (C4 according to the ISO 9223-2012 standard) Optional "seafront" polyester powder coating with anodisation (C5-CX according to the ISO 9223-2012 standard)
Tightness level	IP 66
Impact resistance	IK 08

## OPERATING CONDITIONS

Operating temperature range (Ta)	-30°C up to +50°C / -22°F up to 122°F
----------------------------------	---------------------------------------

· Depending on the luminaire configuration. For more details, please contact us.

## ELECTRICAL INFORMATION

Electrical class	Class 1US, Class I EU, Class II EU
Nominal voltage	120-277V – 50-60Hz 220-240V – 50-60Hz 347-480V – 50-60Hz
Power factor (at full load)	0.9
Surge protection options (kV)	4 10
Electromagnetic compatibility (EMC)	EN 55015:2013/A1:2015, EN 61000-3-2:2014, EN 61000-3-3:2013, EN 61547:2009, EN 62493:2015
Control protocol(s)	1-10V, DALI
Control options	Lumgate, Bi-power, Custom dimming profile, Remote management
Associated control system(s)	Advanced Tunnel Solution (ATS)

· 120-277V input voltage range available in limited configurations

## OPTICAL INFORMATION

LED colour temperature	3000K (Warm White 730) 4000K (Neutral White 740)
Colour rendering index (CRI)	>70 (Warm White 730) >70 (Neutral White 740)

## LIFETIME OF THE LEDS @ TQ 25°C

All configurations	100,000h - L90
--------------------	----------------

## DIMENSIONS AND MOUNTING

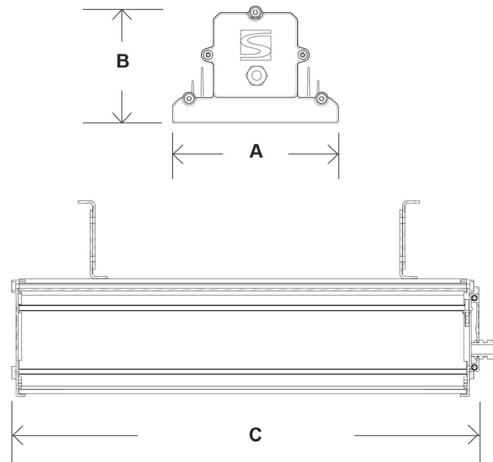

AxBxC (mm   inch)	GL2 COMPACT 1 - 193x137x338   7.6x5.4x13.3 GL2 COMPACT 2 - 193x137x468   7.6x5.4x18.4 GL2 COMPACT 3 - 193x137x538   7.6x5.4x21.2 GL2 COMPACT 4 - 193x137x718   7.6x5.4x28.3 GL2 COMPACT 5 - 193x137x1058   7.6x5.4x41.7 GL2 COMPACT 2 LUMGATE - 193x137x468   7.6x5.4x18.4 GL2 COMPACT 4 LUMGATE - 193x137x718   7.6x5.4x28.3 GL2 COMPACT 5 LUMGATE - 193x137x1058   7.6x5.4x41.7
Weight (kg   lbs)	GL2 COMPACT 1 - 4   8.8 GL2 COMPACT 2 - 5.3   11.7 GL2 COMPACT 3 - 6   13.2 GL2 COMPACT 4 - 7.5   16.5 GL2 COMPACT 5 - 11.5   25.3 GL2 COMPACT 2 LUMGATE - 5   11.0 GL2 COMPACT 4 LUMGATE - 7.5   16.5 GL2 COMPACT 5 LUMGATE - 11.5   25.3
Mounting possibilities	Suspended mounting Surface mounting Direct mounting on ceiling Direct mounting on cable tray

*Size and weight may be different according to the configuration. Please consult us for more information.*









Luminaire	Number of LEDs	Current (mA)	Luminaire output flux (lm) Warm White 730		Luminaire output flux (lm) Neutral White 740		Power consumption (W)		Luminaire efficacy (lm/W)	
			Min	Max	Min	Max	Min	Max	Up to	Photometry
GL2 COMPACT 1	16	350	2300	2500	2300	2600	18.1	18.1	144	
	16	500	3100	3400	3200	3500	25.7	25.7	136	
	16	700	4200	4500	4300	4700	36.3	36.3	129	



Tolerance on LED flux is  $\pm 7\%$  and on total luminaire power  $\pm 5\%$



Luminaire	Number of LEDs	Current (mA)	Luminaire output flux (lm) Warm White 730		Luminaire output flux (lm) Neutral White 740		Power consumption (W)		Luminaire efficacy (lm/W)	
			Min	Max	Min	Max	Min	Max	Up to	Photometry
GL2 COMPACT 2	32	350	4600	5000	4700	5200	35.7	35.7	146	
	32	500	6300	6800	6500	7000	51	51	137	
	32	700	8400	9100	8600	9400	72	72	131	



Tolerance on LED flux is  $\pm 7\%$  and on total luminaire power  $\pm 5\%$



Luminaire	Number of LEDs	Current (mA)	Luminaire output flux (lm) Warm White 730		Luminaire output flux (lm) Neutral White 740		Power consumption (W)		Luminaire efficacy (lm/W)	
			Min	Max	Min	Max	Min	Max	Up to	Photometry
GL2 COMPACT 3	48	350	6900	7500	7100	7800	52	52	150	
	48	500	9400	10200	9800	10600	74	74	143	
	48	700	12600	13600	13000	14100	104	104	136	

Tolerance on LED flux is  $\pm 7\%$  and on total luminaire power  $\pm 5\%$



Luminaire	Number of LEDs	Current (mA)	Luminaire output flux (lm) Warm White 730		Luminaire output flux (lm) Neutral White 740		Power consumption (W)		Luminaire efficacy (lm/W)	
			Min	Max	Min	Max	Min	Max	Up to	Photometry
GL2 COMPACT 4	64	350	9200	10000	9500	10400	67.5	67.5	154	
	64	500	12600	13700	13000	14100	97	97	145	
	64	700	16800	18200	17300	18800	137	137	137	



Tolerance on LED flux is  $\pm 7\%$  and on total luminaire power  $\pm 5\%$



Luminaire	Number of LEDs	Current (mA)	Luminaire output flux (lm) Warm White 730		Luminaire output flux (lm) Neutral White 740		Power consumption (W)		Luminaire efficacy (lm/W)	
			Min	Max	Min	Max	Min	Max	Up to	Photometry
GL2 COMPACT 5	80	350	11500	12500	11900	13000	86	86	151	
	80	500	15800	17100	16300	17700	124	124	143	
	80	700	21000	22800	21700	23500	173	173	136	
	96	350	14100	15100	14500	15600	102	102	153	
	96	500	18900	20500	19600	21200	148	148	143	
	96	700	25200	27300	26000	28200	216	216	131	

Tolerance on LED flux is  $\pm 7\%$  and on total luminaire power  $\pm 5\%$



Luminaire	Number of LEDs	Current (mA)	Luminaire output flux (lm) Warm White 730		Luminaire output flux (lm) Neutral White 740		Power consumption (W)		Luminaire efficacy (lm/W)	
			Min	Max	Min	Max	Min	Max	Up to	Photometry
GL2 COMPACT 2 LUMGATE	16	350	2300	2500	2300	2600	18.1	18.1	144	
	16	500	3100	3400	3200	3500	25.7	25.7	136	
	16	700	4200	4500	4300	4700	36.3	36.3	129	

Tolerance on LED flux is  $\pm 7\%$  and on total luminaire power  $\pm 5\%$



Luminaire	Number of LEDs	Current (mA)	Luminaire output flux (lm) Warm White 730		Luminaire output flux (lm) Neutral White 740		Power consumption (W)		Luminaire efficacy (lm/W)	
			Min	Max	Min	Max	Min	Max	Up to	Photometry
GL2 COMPACT 4 LUMGATE	32	350	4600	5000	4700	5200	35.7	35.7	146	
	32	500	6300	6800	6500	7000	50	50	140	
	32	700	8400	9100	8600	9400	70	70	134	
	48	350	6900	7500	7100	7800	52	52	150	
	48	500	9400	10200	9800	10600	74	74	143	
	48	700	12600	13600	13000	14100	104	104	136	

Tolerance on LED flux is  $\pm 7\%$  and on total luminaire power  $\pm 5\%$



Luminaire	Number of LEDs	Current (mA)	Luminaire output flux (lm) Warm White 730		Luminaire output flux (lm) Neutral White 740		Power consumption (W)		Luminaire efficacy (lm/W)	
			Min	Max	Min	Max	Min	Max	Up to	Photometry
GL2 COMPACT 5 LUMGATE	64	350	9200	10000	9500	10400	71	71	146	
	64	500	12600	13700	13000	14100	100	100	141	
	64	700	16800	18200	17300	18800	140	140	134	
	80	350	11500	12500	11900	13000	87	87	149	
	80	500	15800	17100	16300	17700	124	124	143	
	80	700	21000	22800	21700	23500	176	176	134	
	96	350	13900	15100	14300	15600	104	104	150	
	96	500	18900	20500	19600	21200	148	148	143	
	96	700	25200	27300	26000	28200	208	208	136	

Tolerance on LED flux is  $\pm 7\%$  and on total luminaire power  $\pm 5\%$



